

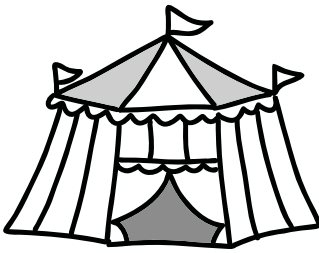

Comic

There is a circus in town.



Nora meets Poppy, one of the artists.

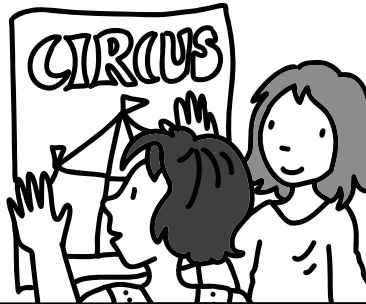

She tells her that she and her family live in a circus wagon.

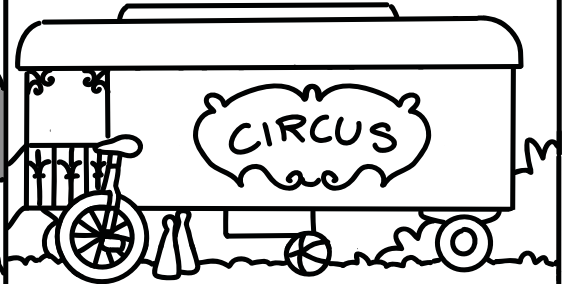

Nora wants to see how Poppy lives. She has a ticket for the show today.

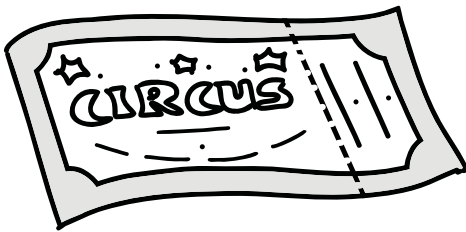

Nora locked the ticket in her treasure chest.

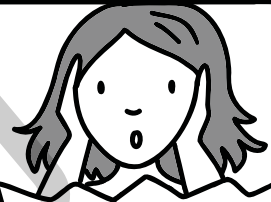
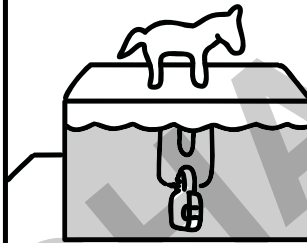

But she cannot remember the code!
Can you help her in time?



Content of the treasure chest (1)

With your help Nora can visit Poppy in her camper after the show.

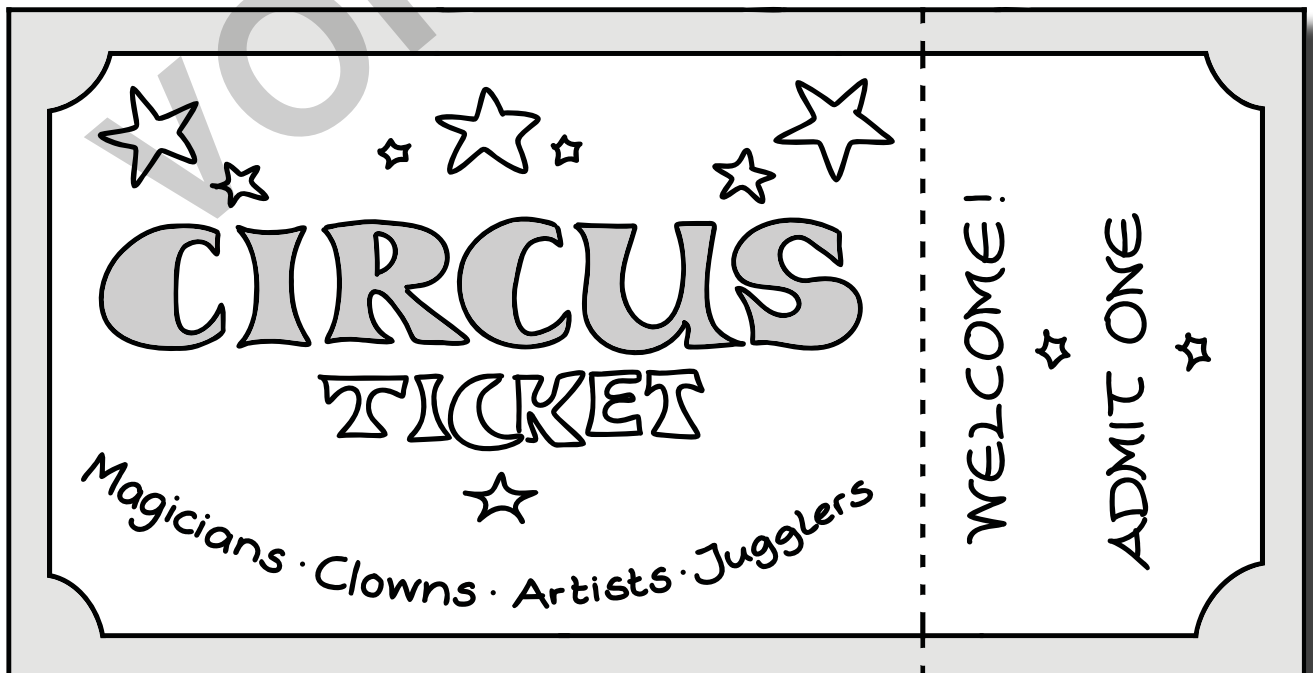



Content of the treasure chest (2)

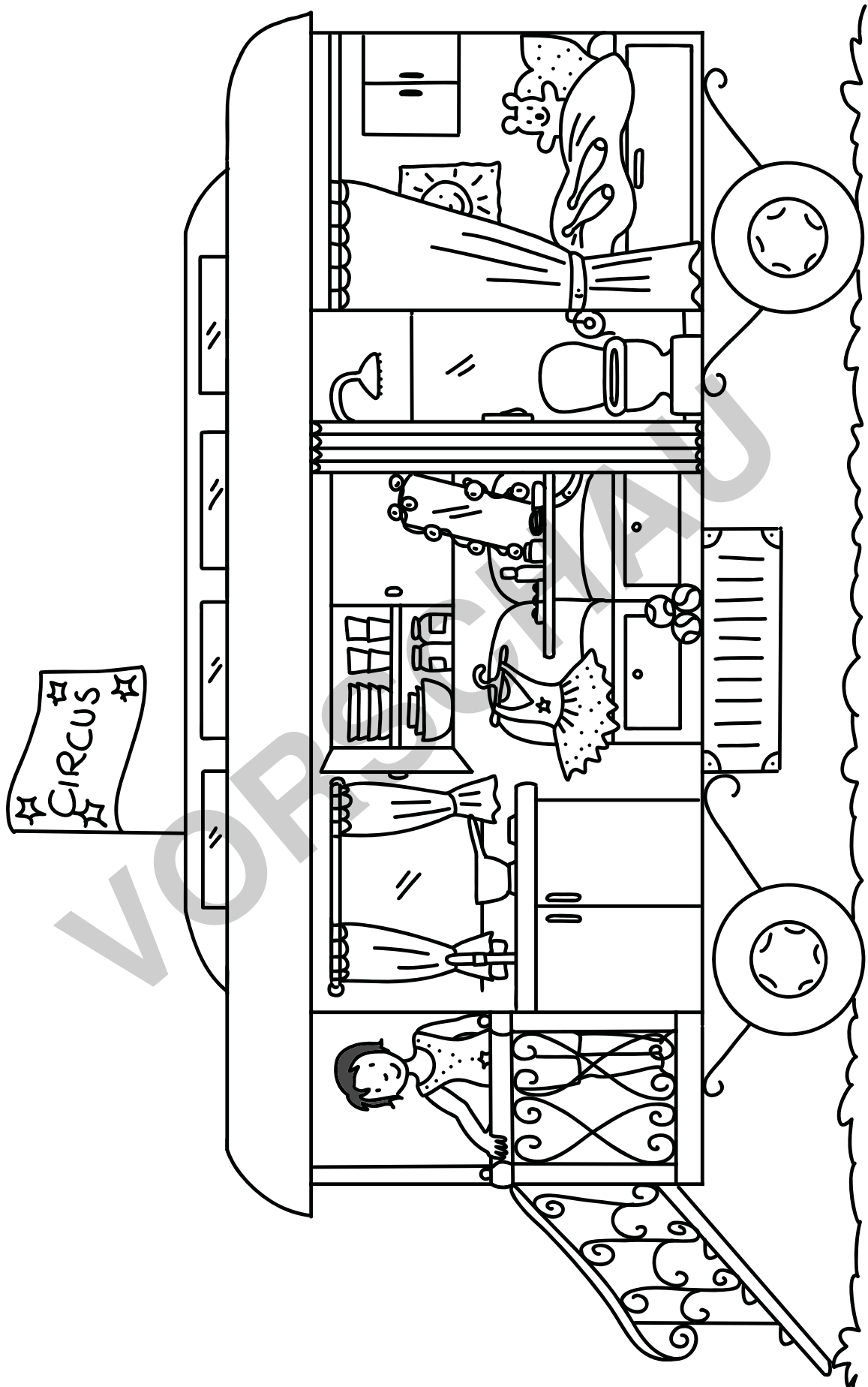



My favourite room

Listen and choose correctly.

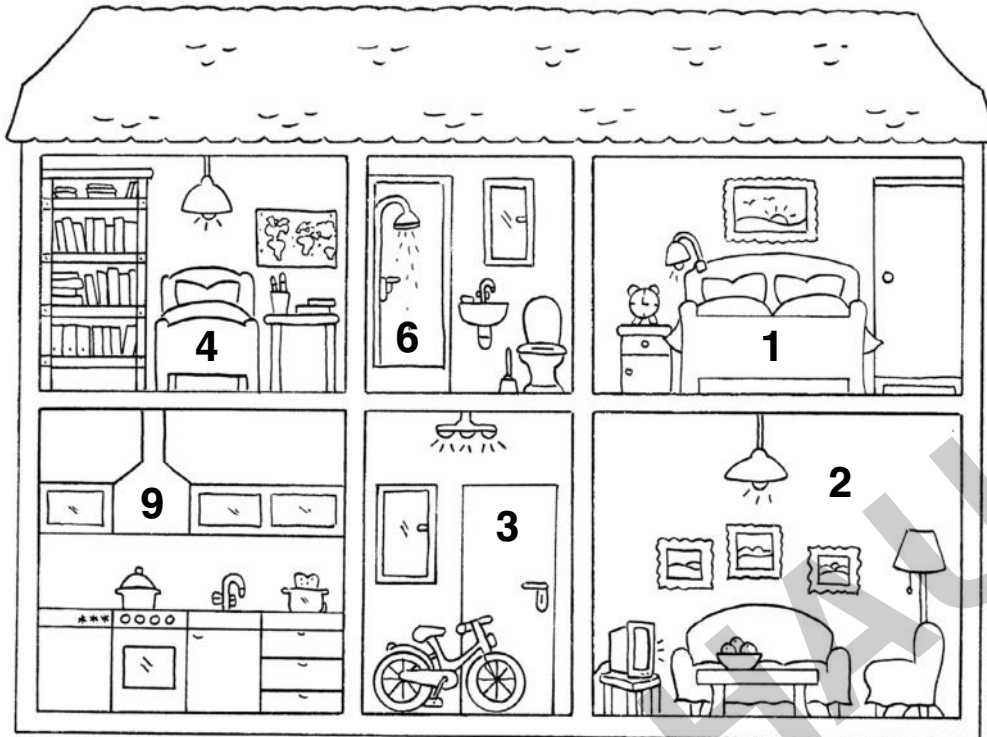

Sara: _____
 Peter: _____
 Leo: _____



Hint card: My favourite room

We are the Sheffields and this is our home.

My name is Sara.
 My favourite room
 has a picture on the
 wall.
 There are many
 books in this room.
 It is my bedroom.



My name is Peter.
 I am Sara's father.
 My favourite room has
 a sink.
 There are no pictures
 on the walls.
 I like to cook there for
 my family.
 It is the kitchen.



My name is Leo.
 I am the family cat.
 My favourite room in
 the house is very
 comfortable.
 I like sleeping there a
 lot on the sofa.
 In the evening I like
 watching TV with
 Sara and Peter.
 My favourite room is
 the living room.





Word search puzzle

Find all the words.

G	A	R	D	E	N	C
Q	R	I	O	P	R	U
G	H	A	I	T	L	P
E	F	E	U	S	H	B
G	A	R	A	G	E	O
D	S	G	H	I	M	A
N	A	S	E	T	N	R
U	T	I	O	L	G	D
K	I	T	C	H	E	N

F	H	B	U	I	N	S
F	E	A	F	K	B	B
E	P	O	K	Z	E	I
N	C	W	A	Q	D	F
C	V	I	F	D	R	A
E	R	O	O	F	O	S
U	H	I	S	D	O	E
W	E	R	U	F	M	L
L	I	U	G	E	X	P

D	S	O	F	A	B	V
O	A	D	S	F	A	O
O	T	H	I	U	T	R
R	O	P	L	A	H	I
C	H	A	I	R	R	U
U	T	D	N	M	O	L
I	H	A	O	L	O	S
T	A	B	L	E	M	C
G	U	T	H	E	W	E





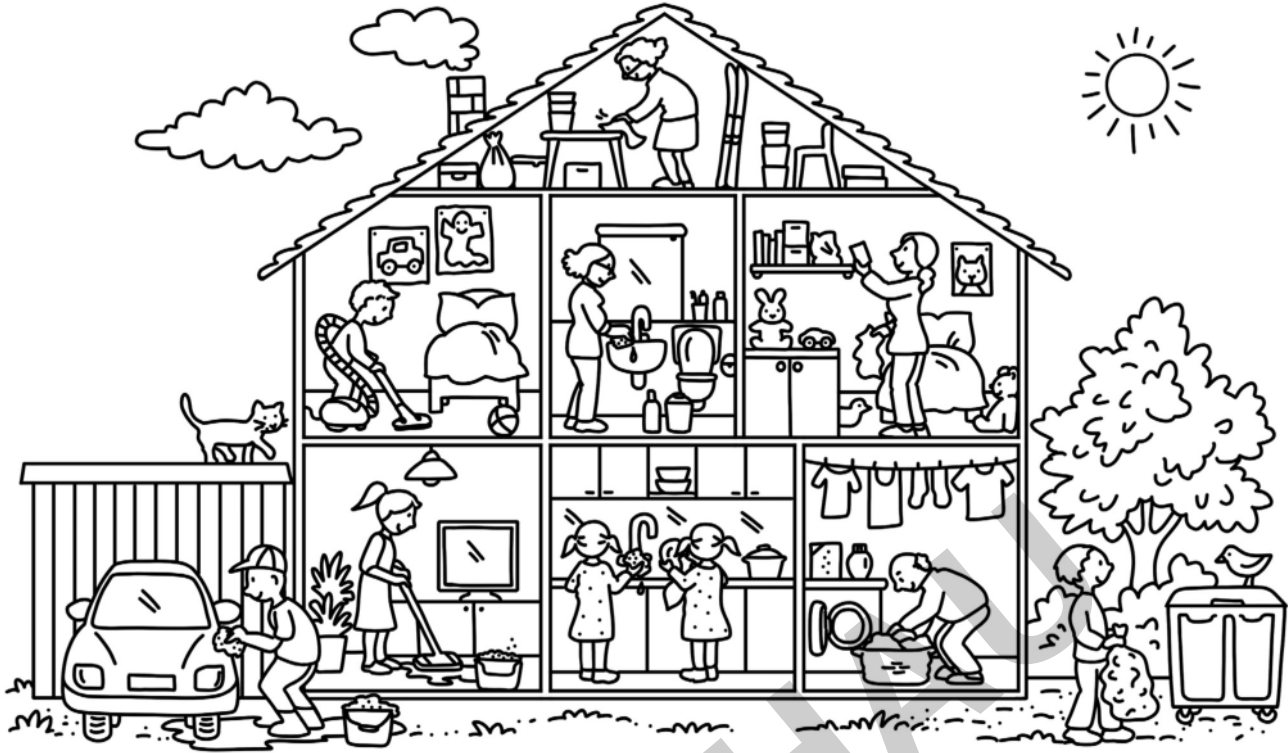

Cleaning day



Things...

Fill in the right words.

lamp – radio – window – sofa – chair – television
bed – cupboard – floor

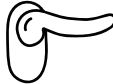
 things you can sit on	 things you can turn on or off	 things you can open or close
Count: <input type="text"/>	Count: <input type="text"/>	Count: <input type="text"/>



Which room?

What can you see in the rooms? Connect.

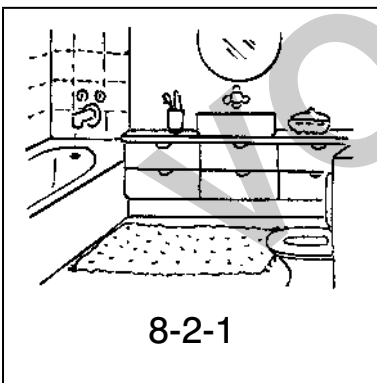
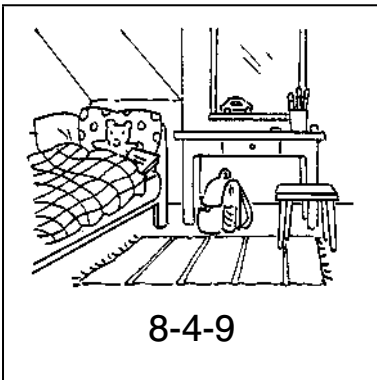
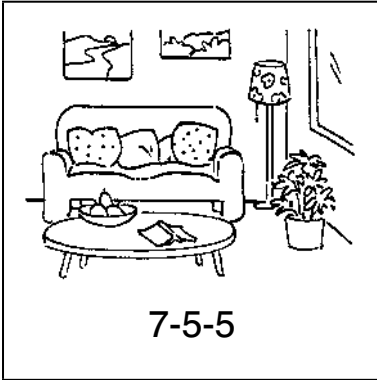

sofa

shelf

desk

oven

sink

pillow

bed

mirror

toilet

cupboard

